



## XT series Interface Plug-in Relay 8 to 16 Amp, 1 or 2 Pole

File E214025  
 NR B758

Users should thoroughly review the technical data before selecting a product part number. It is recommended that users also seek out the pertinent approval files of the agencies/laboratories and review them to confirm the product meets the requirements for a given application.

### Features

- Compact design is only 0.54" (13.7mm) wide.
- Choice of SPDT rated 16A or DPDT rated 8A.
- Plugs into same sockets as our RT series.
- Sensitive DC coil (400mW) or AC coil (0.58VA @60 Hz).
- Test lever, mechanical indicator, LED and protection diode options.
- 4kV (8mm) coil-to-contact isolation.
- RoHS Compliant (Directive 2002/95/EC).

### Contact Data

**Arrangements:** 1 Form C (SPDT) and 2 Form C (DPDT).  
**Contact Set:** Single contact.  
**Type of Interruption:** Micro-disconnection.  
**Material:** Silver-nickel 90/10.

**Expected Mechanical Life:** DC coil 10 million operations minimum.  
AC coil 5 million operations minimum.

**Switching Frequency With / Without Load:** 6 / 600 operations min<sup>-1</sup>.

### Rated Current

Arrangement	1 Form C	2 Form C
Rated Current	16A	8A
Rated Voltage	240VAC	240VAC
Maximum Switching Voltage	400VAC	400VAC
Rated Breaking Capacity	4,000VA	2,000VA
Maximum Make Current (max 4s, 10% DF)	30A	15A

### Contact Ratings

(All are for Form C contacts, 70°C, 50% duty factor)

Type	Load	Cycles
XT37	16A, 250VAC, EN61810-1	30 x 10 <sup>3</sup>
XT48	8A, 250VAC, DC Coil, EN61810-1	50 x 10 <sup>3</sup>
XT48	8A, 250VAC, AC Coil, EN61810-1	30 x 10 <sup>3</sup>
XT31	16A, 250VAC, EN61810-1	30 x 10 <sup>3</sup>
XT42	8A, 250VAC, DC Coil, EN61810-1	50 x 10 <sup>3</sup>
XT42	8A, 250VAC, AC Coil, EN61810-1	30 x 10 <sup>3</sup>
XT37	16A, 250VAC, General Purpose, UL508	30 x 10 <sup>3</sup>
XT48	8A, 250VAC, General Purpose, DC Coil, UL508	50 x 10 <sup>3</sup>
XT48	8A, 250VAC, General Purpose, AC Coil, UL508	30 x 10 <sup>3</sup>
XT31	16A, 250VAC, General Purpose, UL508	30 x 10 <sup>3</sup>
XT42	8A, 250VAC, General Purpose, DC Coil, UL508	50 x 10 <sup>3</sup>
XT42	8A, 250VAC, General Purpose, AC Coil, UL508	30 x 10 <sup>3</sup>

### Insulation

**Initial Dielectric Strength Between Open Contacts:** 1,000Vrms.

**Initial Dielectric Strength Between Coil and Contacts:**  
5,000Vrms with socket RT78726.  
4,000Vrms with socket RT78725.

**Initial Dielectric Strength Between Poles:** 2,500Vrms.

**Clearance / Creepage Coil-to-Contact:** ≥ 8mm / 8mm.

**Material Group of Insulation Parts:** ≥ IIIa.

**Tracking Index of Relay Base:** PTI 175 V.

**Insulation to IEC 60664-1**

**Type of insulation coil-contact circuit:** Reinforced.

**Type of insulation open contact circuit:** Functional.

**Type of insulation adjacent contact circuits:** Basic.

**Rated Insulation Voltage:** 250V.

**Pollution Degree:** 3 2.

**Rated Voltage System:** 240V 400V.

**Overvoltage Category:** III.

### Coil Data

**Rated Coil Voltage Range:** 6-110VDC; 24-230VAC.

**Operative Range:** 2.

**Coil Insulation System (Per UL1446):** Class F.

**Coil Power (Typ.):** DC – 400mW; AC – 0.76VA @ 50Hz. / 0.58VA @ 60Hz.

### DC Coil Data @ 23°C

Nominal Voltage VDC	DC Resistance in Ohms	Must Operate Voltage VDC	Drop-out Voltage VDC	Power for Opt. LED (mW)
12	360 ±10%	8.4	1.2	10
24	1,440 ±10%	16.8	2.4	19
48	5,520 ±10%	33.6	4.8	39
110	28,800 ±12%	77.0	11.0	87

NOTE: Observe coil polarity on models with the optional protection diode. A1 is positive and A2 is negative.

### AC Coil Data @ 23°C

Nominal Voltage VAC	DC Resistance in Ohms	Must Operate Voltage (VAC) 50 Hz / 60 Hz	Drop-out Voltage VAC	Power for Opt. LED (VA)
24	350 ±10%	18.0 / 20.4	3.6	0.012
115	8,100 ±15%	86.3 / 97.8	17.3	0.054
230	32,500 ±10%	172.5 / 196.5	34.5	0.073

### Operate Data

**Must Operate Voltage:** See Coil Data table.

**Operate Time (DC Coil):** 9 ms typical, at nom. voltage.

**Release Time (DC Coil):** 6 ms typical, at nom. voltage.

**Bounce Time (DC Coil) NO / NC:** 4 ms / 12 ms.

### Environmental Data

**Temperature Range:**

**Operating:** -40°C to +70°C.

**Vibration Resistance (functional):** 20g N/O, 5g N/C, 30 to 500 Hz.

**Shock Resistance (destruction):** 100g.

### Mechanical Data

**Flammability Class (per UL94):** V-0.

**Category of Protection:** RTII.

**Mounting Distance:** 4.5mm, dense packing of sockets.

**Relay Weight:** .56 oz. (16 g) approximately.

### Max. DC Load Breaking Capacity (resistive load)

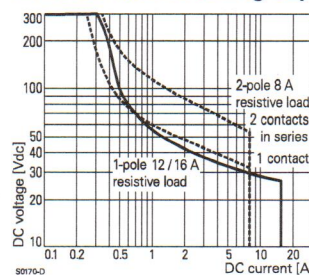



**Coil Operating Range**

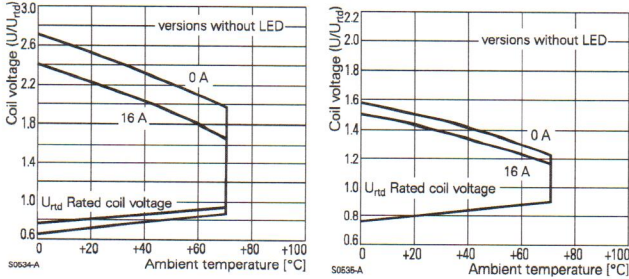

**Electrical Life**

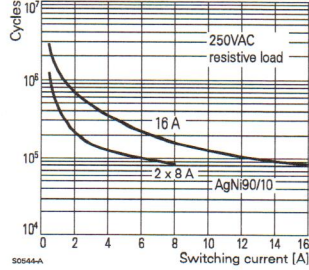

**Ordering Information**

Typical Part Number >

**XT**

**3**

**1**

**4**

**024**

**1. Basic Series:**

XT = Compact Plug-in General Purpose Relay.

**2. Version:**

3 = 1 pole, 16A, 5mm pinning                      4 = 2 pole, 8A, 5mm pinning

**3. Contact Arrangement and Test/Indicator Option:**

1 = 1 Form C (SPDT), no test lever or mechanical indicator.    7 = 1 Form C (SPDT), with test lever and mechanical indicator.  
2 = 2 Form C (DPDT), no test lever or mechanical indicator.    8 = 2 Form C (DPDT), with test lever and mechanical indicator.

**4. Contact Material:**

4 = AgNi 90/10.

**5. Coil Code:**

DC Coils	DC Coils with Optional LED and Diode	AC Coils	AC Coils with Optional LED
012 = 12VDC	LB2 = 12VDC, with LED and protection diode	524 = 24VAC	R24 = 24VAC, with LED
024 = 24VDC	LC4 = 24VDC, with LED and protection diode	615 = 115VAC	S15 = 115VAC, with LED
048 = 48VDC	LE8 = 48VDC, with LED and protection diode	730 = 230VAC	T30 = 230VAC, with LED
110 = 110VDC	M80 = 110VDC, with LED and protection diode		

**Our authorized distributors are more likely to stock the following items for immediate delivery.**

- XT314012   XT314524   XT374LB2   XT374R24   XT374T30   XT424024   XT424615   XT484LC4   XT484S15  
XT314024   XT314615   XT374LC4   XT374S15   XT424012   XT424524   XT484LB2   XT484R24   XT484T30

NOTE: All part numbers listed above are RoHS compliant.

**Outline Dimensions**

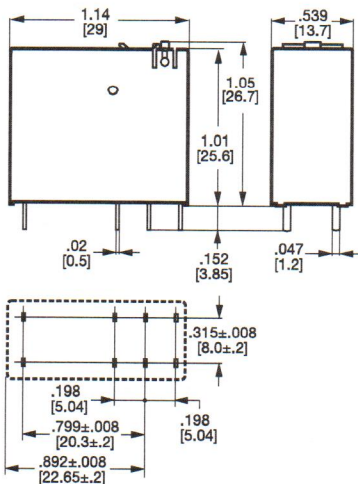

**Wiring Diagrams (Bottom Views)**

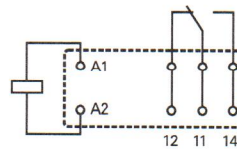

1 FORM C (SPDT)

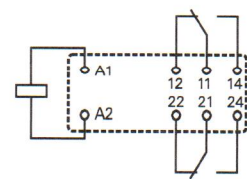

2 FORM C (DPDT)

NOTE: Observe coil polarity on models with the optional protection diode. A1 is positive and A2 is negative.

**Conversion of Test Lever to Locking Capability**

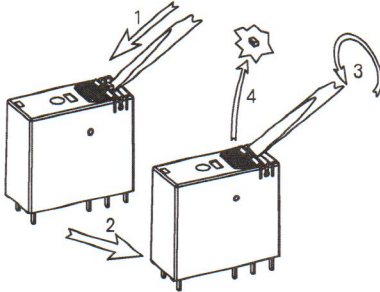

A standard XT series relay with a test lever is delivered with the locking function of the test lever disabled. In this state, a small plastic nib is designed to interfere with the lever moving to the locking position in normal operation; however, if the test lever is moved too forcefully, it may bypass the normal test position and go to the locked position.

To enable the locking function, please remove the small plastic nib as illustrated in the drawing at left. The lever may then move to its locking position with no undue force required.

**Available Sockets & Accessories for use with XT Series Relays**

**RT7872P  
DIN Rail Socket with Poke In Terminals, Logical Arrangement**

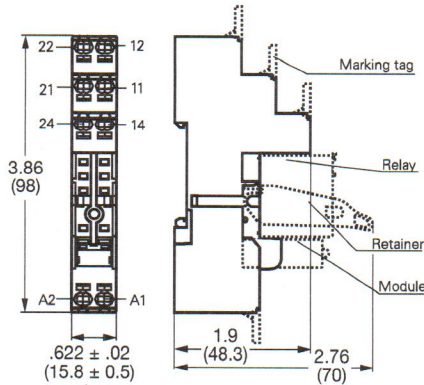

**RT78726  
DIN Rail Socket with Screw Terminals, Logical Arrangement**

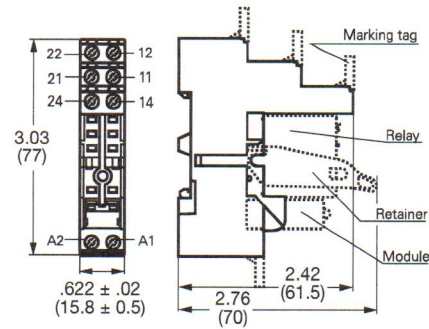

**RT78725  
DIN Rail Socket with Screw Terminals, Conventional Arrangement**

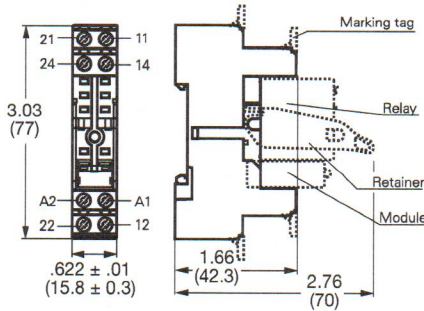

**Socket Selection Table**

Socket Part No.	Termination	Mounting Style
RT78725	Screw Terminals, Conventional Arrangement	DIN-rail
RT78726	Screw Terminals, Logical Arrangement	DIN-rail
RT7872P	Poke-in (screwless) Terminals, Logical Arrangement	DIN-rail

**Accessory Selection Table**

Accessory Part No.	Description
RT17017	Plastic Retaining Clip
RT17040	Plastic Snap-on Marking Tag
RT170P1	Jumper Bar (for use with Socket RT170P1)
PTM... (various)	LED and Protection Modules*

\* Consult factory for details concerning various available modules.

NOTE: All part numbers listed above are RoHS compliant.



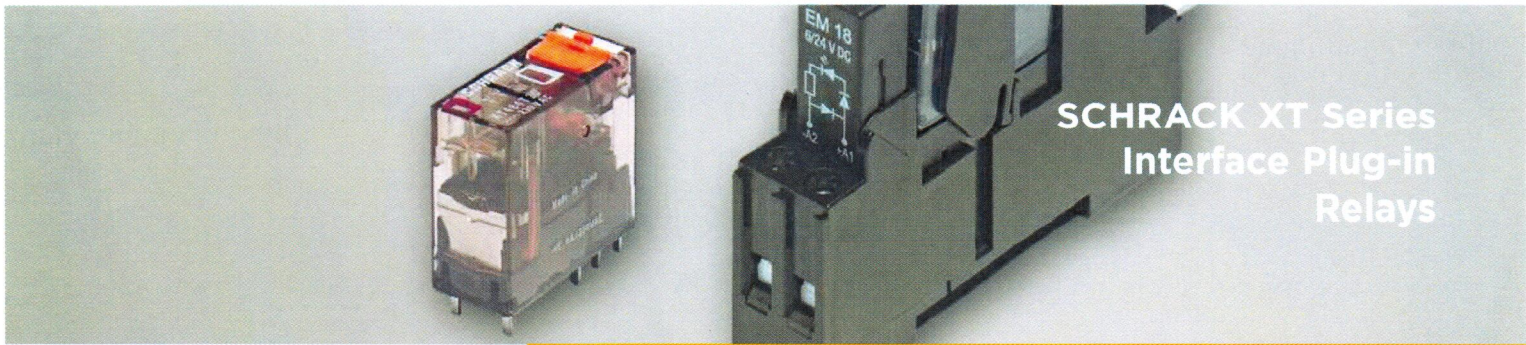

## SCHRACK XT Series Interface Plug-in Relays

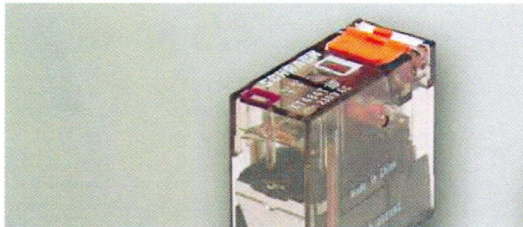
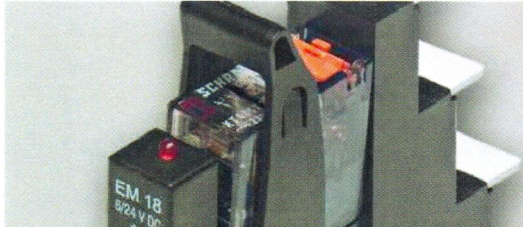

### PRODUCT OFFERING

Part Number	Contact Arrangement	Coil Voltage	Test Lever & Mechanical Indicator	Optional Circuit	Internal Part Number
XT314012	1 Form C (SPDT)	12VDC	No	No	1887100-2
XT314024	1 Form C (SPDT)	24VDC	No	No	1887100-3
XT374LB2	1 Form C (SPDT)	12VDC	Yes	LED & PD	1887112-3
XT374LC4	1 Form C (SPDT)	24VDC	Yes	LED & PD	1887112-1
XT314524	1 Form C (SPDT)	24VAC	No	No	1887101-3
XT314615	1 Form C (SPDT)	115VAC	No	No	1887101-7
XT374R24	1 Form C (SPDT)	24VAC	Yes	LED	1887113-3
XT374S15	1 Form C (SPDT)	115VAC	Yes	LED	1887113-4
XT374T30	1 Form C (SPDT)	230VAC	Yes	LED	1887113-1
XT424012	2 Form C (DPDT)	12VDC	No	No	1887200-2
XT424024	2 Form C (DPDT)	24VDC	No	No	1887200-3
XT484LB2	2 Form C (DPDT)	12VDC	Yes	LED & PD	1887212-3
XT484LC4	2 Form C (DPDT)	24VDC	Yes	LED & PD	1887212-1
XT424524	2 Form C (DPDT)	24VAC	No	No	1887201-3
XT424615	2 Form C (DPDT)	115VAC	No	No	1887201-7
XT424R24	2 Form C (DPDT)	24VAC	Yes	LED	1887213-3
XT424S15	2 Form C (DPDT)	115VAC	Yes	LED	1887213-4
XT424T30	2 Form C (DPDT)	230VAC	Yes	LED	1887213-1

Chart above reflects some of the more common part numbers. Relays with different options are available.

### OUTLINE DIMENSIONS & WIRING DIAGRAMS

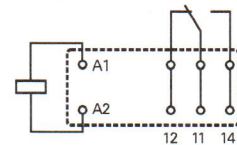
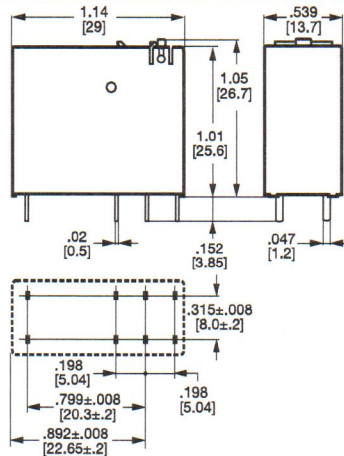

1 Form C  
(SPDT)

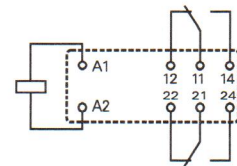

2 Form C  
(DPDT)

### ACCESSORIES

Part Number	Description	Internal Part Number
RT78726	Screw terminal socket, DIN mount, logical terminal arrangement	6-1415035-1
RT78725	Screw terminal socket, DIN mount, conventional terminal arrangement	1860306-1
RT7872P	Poke-in (screwless) terminal socket, DIN mount, logical terminal arrangement	1860200-1
XT17017	Plastic retaining clip for use with XT relay and the above-listed sockets	2022104-1
RT17040	Marking tag for use with the above-listed sockets	2-1415038-1
RT170P1	Jumper bar for use with RT7872P sockets	1860211-1
PTM...	Plug-in LED and protection modules for optional use with above-listed sockets	Various

NOTE: All relay and accessory part numbers listed in the column at right are RoHS compliant.

Note: Specifications and availability are subject to change without notice. Consult data sheet 1-1773450-2 for detailed specifications.